

Elettronica Santerno S.p.A.

Strada Statale Selice, 47
40026 Imola (Bo) Italia
t +39 0542 489711
f +39 0542 489722
info@santerno.com
santerno.com

**Stabilimento Produttivo**

Via della Concia, 7
40023 Castel Guelfo
(BO) Italia
t +39 0542 489311

SUNWAY STATION 1520 1000V LS

Fully Integrated OUTDOOR Solar Power Station

Uffici Milano

Via Giotto, 4
20040 Cambiagio
(Mi) Italia
t +39 02 95138126
t +39 02 95179254
t +39 02 95179458
f +39 02 95139216

Sede Legale

Via Olmo, 37
35011 Campodarsego
(Pd) Italia
t +39 049 9219111
f +39 049 9289111

Cap. Soc. € 2.500.000 i.v.
Codice Fiscale e Partita Iva
03686440284
R.E.A. PD 328951
Cod. Mecc. PD 054138
Cod. Ident. IVA Intracom.
IT03686440284

Elettronica Santerno S.p.A.
Società soggetta all'attività
di direzione e coordinamento
di Carraro S.p.A.



Designed for large utility scale applications, **SUNWAY STATIONS** feature best-in-class technology without compromises providing the highest power density and reliability.

With all the technical advantages and flexibility of SUNWAY TG inverters, SUNWAY STATIONS allow optimum configuration of medium and large PV plants providing the lowest system cost and the maximum efficiency.

BENEFITS

- Based on SUNWAY TG solar inverters
- Pre-assembled substations, fully fitted out and tested to reduce the plant costs to a minimum, ensuring easy laying and wiring
- Built with sandwich sheet panels and integrated vibrated reinforced concrete foundations for easy transport (structure fully made of concrete optionally available, LC version)
- High efficiency MV distribution transformer
- Extended configurability of the MV section to adapt to any specific plant requirement
- Full access to inverters and accessories for optimum reliability and serviceability
- Grid Code integrated features (LVRT, Reactive Power Control, Frequency and Voltage control) in compliance with the most advanced European, North American and WW standards
- Integrated DC-side protection provided by DC fuses and disconnect switch with release coil
- Integrated Ground Fault Detection system and miswiring protection on DC side
- Integrated Modbus on RS485 and TCP/IP on Ethernet data connection, integrated fiber optic ports
- Remote monitoring optionally available via Santerno Web Portal (www.sunwayportal.it)
- Integrated inputs for environmental sensors
- Possibility to install photovoltaic modules requiring one grounded pole, both positive and negative pole
- Thorough manufacture with first class materials

Main features	
Model	SUNWAY STATION 1520 1000V LS
Inverters	2 x SUNWAY TG750 1000V TE - 360 STD
MPPT voltage range ⁽¹⁾	550 - 820 V
Number of independent MPPTs	2
AC power frequency	50 Hz
Rated Power Factor (range)	1-0.9 lead/lag
Maximum operating altitude ⁽²⁾	4000 m a.s.l.
Maximum value for relative humidity	100% condensing
Input (DC)	
Max DC voltage	1000 V
Rated input power	1544 kW
PV voltage ripple	<1%
Maximum DC inputs fuse-protected	2 x 16
Maximum short circuit PV input current	2 x 1500 A
Output (AC)	
Rated output current, LV side	2400 A
Rated output power, LV side	1498 kW
Power threshold	1% of Rated AC inverter output power
Total AC current distortion	≤ 3%
Rated AC voltage, MV side	6 to 24 kV (up to 30 kV on request)
Connection phases, MV side	3
Inverter efficiency - LV side	
Maximum /EU/ CEC efficiency	98.5% / 98.1 % / 98%
MV transformer	
Type	Oil/Cast resin
Rated power	1650 kVA
Fuse protection	Yes
Temperature control	Yes
Oil pressure control ⁽³⁾	Yes
Dimensions and weight ⁽⁴⁾	
Cabinet Dimensions (WxHxD)	8.4 x 3.2 x 2.4 m (to be confirmed)
Overall Weight	25000 Kg (to be confirmed)

Elettronica Santerno reserves the right to make any technical changes to this document without prior notice.

NOTES

⁽¹⁾ At rated Vac and Cos φ =1

⁽²⁾ Up to 1000 m without derating

⁽³⁾ Only for oil type transformers

⁽⁴⁾ Dimensions and weight not applicable to Sunway Station LC version with structure fully made of concrete

Elettronica Santerno S.p.A. reserves the right to make any technical changes to this document without prior notice.

Protective devices	
DC protection against overvoltage (SPD)	Yes
DC input current monitoring	Optional
DC side disconnection device	DC disconnect switch
DC ground fault monitoring	Yes
AC disconnection device, LV side	AC circuit breaker
AC disconnection device, MV side	AC disconnect switch
AC ground fault monitoring, LV side	Optional
Grid fault monitoring	Yes
Compartment temperature control	Yes
Emergency stop switch	Yes
Safety key distribution system	Yes
Communication Interfaces	
Power modulation	Via Remote Control (RS485, Ethernet)/analog inputs
PV plant monitoring	Optional (via Santerno Web Portal)
Protocols	Modbus RTU/Modbus TCP/IP
Ethernet/RS485/Optical fiber	Yes/Yes/Optional
Premium Remote Monitoring	Optional
Additional features	
PLC for system control	Yes
Ethernet switch	Yes
Anticondensation heater	Yes
Inputs for environmental sensors	Up to 6 per Inverter
Pulsed counters	Up to 2 per Inverter
Cooling system - Airflow	Forced air ventilation
UPS, LV side	Optional 4/6/10 kVA
Fiscal meter	Optional
Grid interface device protection	Optional
Self-consumption meter	Optional
Kit for earthed negative/positive pole	Optional
Fire sensors	Optional
Personal protective kit: fire extinguisher, dielectric gloves and insulating rubber mat	Yes

Layout

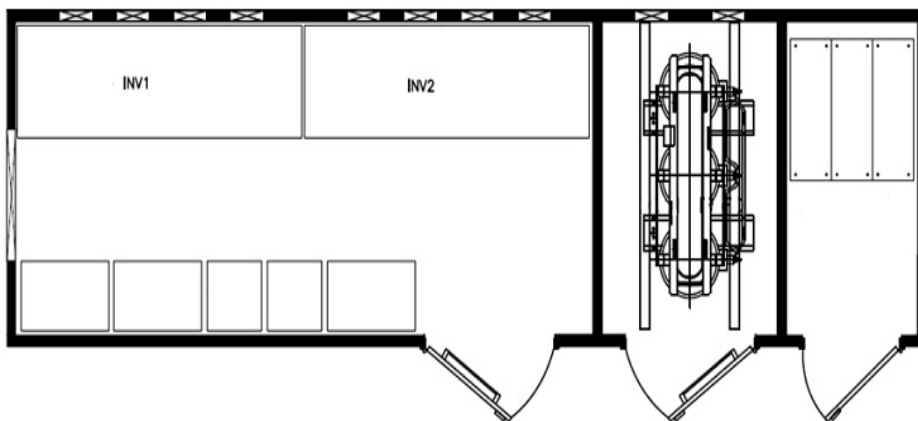
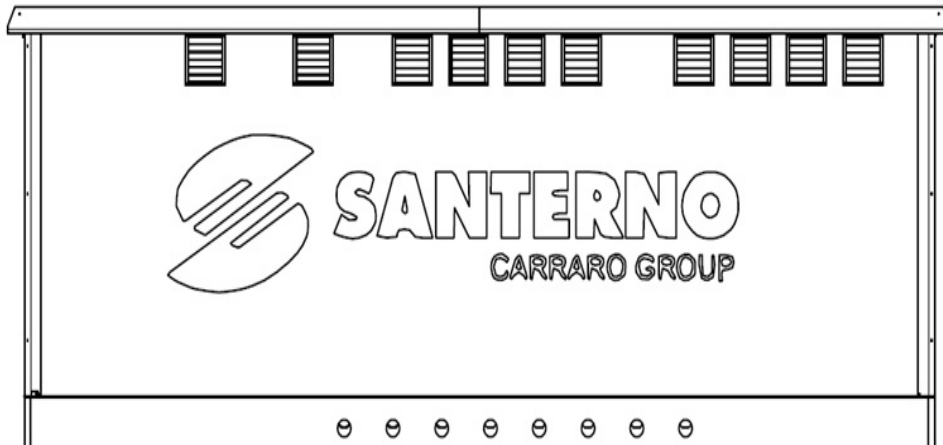
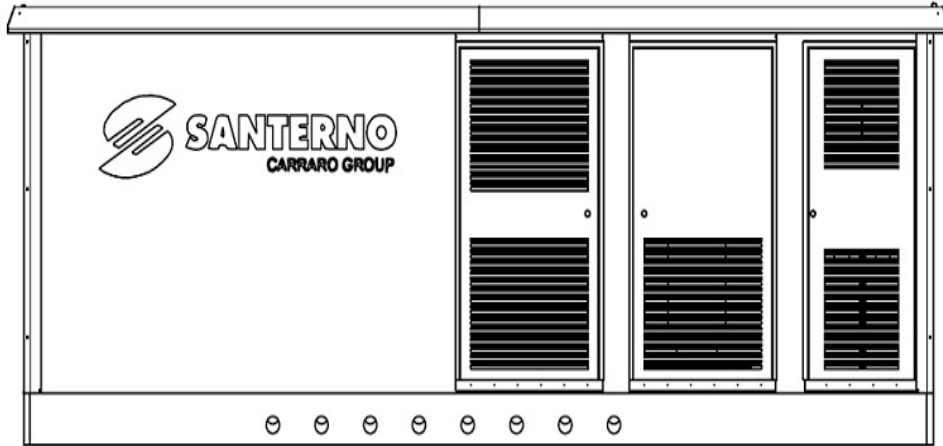

Block Diagram

The Sunway Station is supplied complete with internal wiring (power wiring and auxiliary wiring). Standard supply does NOT include outgoing cables and wiring.

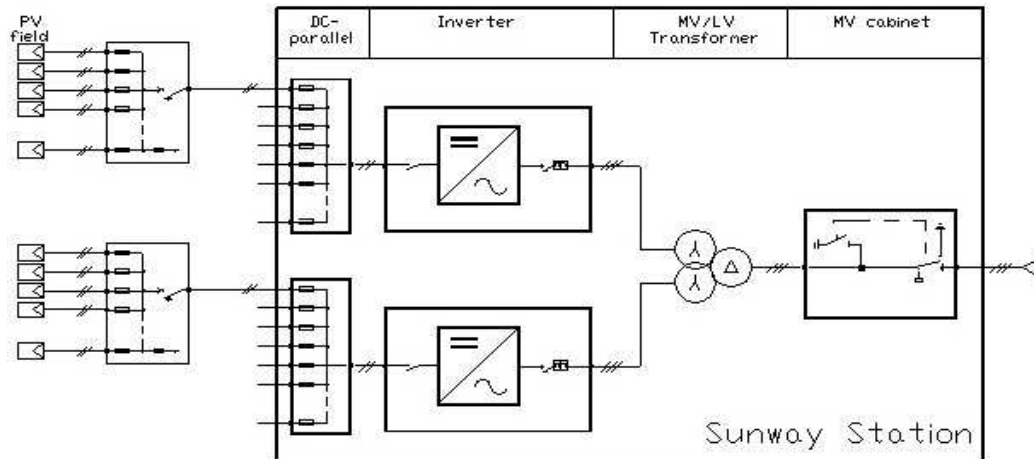

Standard block diagram of Sunway Station ⁽⁵⁾

Main Normative References

SANTERNO SUNWAY STATIONS have been developed, designed and manufactured in accordance with the latest requirements of the Low Voltage directives, Electromagnetic Compatibility directives and Grid Connection standards.

Standards ⁽⁶⁾	
Compliance	EN 61000-6-2 EN 61000-6-4
MV Cabinet	IEC 62271-200 CEI-EN 62271-102
LV/MV Transformer	IEC 60076-11
Cabinet structure/internal wiring	CEI 64-8 CEI 11-35 CEI EN 61330
Grid connection	CEI 0-16, A70 Arrêté du 23 Avril 2008 RD 1633/2000, RD 661/2007 BDEW

NOTES

⁽⁵⁾ More configuration are available

⁽⁶⁾ Additional certificates available on request